



**Motic**

MORE THAN MICROSCOPY

BA

# BA410

Clinical & Lab  
Microscope  
Platform



# BA410 | Clinical&Lab Microscope Platform

**M**otic's premier BA410 is the flagship model of its BA Upright Compound Series, and exhibits Motic's advancing optical development approach in creating this high-end microscope. Designed for multiple disciplines from University through Clinical, Laboratory, and Research applications, the BA410 offers true professional quality with a full complement of accessories, making it a valued addition for any biological application. The BA410, when combined with any Moticam digital camera, also provides a powerful documentation tool for reporting or teaching assignments.







## Microscope Stand

Through continuous professional usage, ergonomic functionality is increasing in importance in the design of a quality microscope stand. With this in mind, Motic's BA410 design was formulated around actual user parameters in order to maximize comfort during prolonged usage times.

The inverted "Y" shape of the stand gives extra lateral stability to the BA410. Low position focus controls and stage movement mechanisms were designed to minimize user fatigue. The easy-to-reach illumination intensity control as well as the free-locking stage position option guarantee extended comfort and effortless operation.

All of the above, when combined with the individual's choice of an eyepiece tube and accessories, makes the setup of a personal microscope possible: suitable for all types of user configurations and applications.

## Eyepiece Tubes

Designed with a comfortable viewing angle of 30°, the standard BA410 eyepiece tubes (binocular and trinocular) offer a 22 mm Field of View (FOV 22) for fast and comfortable observations and screening. The interpupillary distance can be adjusted in the range of 48-75mm; while a new rubber grip ensures precise and safe adjustment.

All standard eyepiece tubes now offer an extended "butterfly" swivel adjustment to increase the viewing height to accommodate individual user's positioning. The BA410 also offers an optional eye-level riser of 20mm for further microscope customization.

Aside from the regular Binocular tube, Trinocular photo tubes can be obtained with 3 optical beam splitter options:

**100:0/20:80**

Standard configuration

**100:0/0:100**

Recommended for Fluorescence

**100:0/0:100/20:80**

Maximum flexibility





## Ergonomic Tubes

For prolonged viewing demands, the BA410 offers a complement of ergonomic viewing head options, with a FOV 22 and an interpupillary distance of 55-75mm. Two different ergonomic tubes are available:

The Binocular Ergo tube has a variable viewing angle of 4°-30°.

The Binocular Ergo-Plus tube also offers an additional extension movement of 35mm.

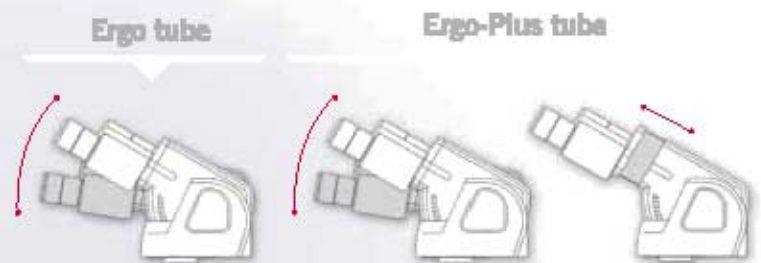

## Eyeieces

Motic's Infinity Corrected CCIS® Optical system with a field flatness up to 22mm and the high eye point principle of the BA410's eyepieces ensure true colour and sharp images, while minimizing eye fatigue and strain. As a standard, diopter adjustment is integrated to assist spectacle wearers and for reticule usage.

Beside the standard 10X eyepiece magnification, the BA410 series also offers higher magnification eyepieces.

Description	F.N.
Widefield N-WF 10X	20
Widefield N-WF 10X	22
Widefield N-WF 12.5X	18
Widefield N-WF 15X	16

## Eyepiece Reticules

The Motic BA410 offers a variety of reticules for measuring purposes. These include:

Special reticules are also available on request



Graduated linear hair point = 0.1mm/10mm



Graduated cross hair point = 0.1mm/10mm

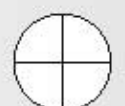

Plain cross hair



## Nosepiece

The BA410's ball bearing driven nosepiece with internal click stops at each objective stop, ensures precision and repeatability with every magnification change. Reversed nosepiece orientation accommodates both rapid slide changes without objective contamination, and ease of reading the objective information. Quintuple or Sextuple nosepiece configured models are available.

## Objectives

The Motic BA410 offers a **new class of EC-H optics** that sets the standard in price-performance in optical quality. Multi-layer coated glass for **enhanced contrast** and **lead-free** manufacturing according to **RoHS standards** are significant features of this new class of Motic CCIS® objectives.

With excellent spherical aberration correction to significantly improve each lens' field flatness and better resolution, the **EC-H optics offer superior colour reproduction and fidelity**. In addition to bright field, the same quality and craftsmanship is also available within the new EC-H Phase objective set.

Also common now to all new EC-H lenses is a remarkably **improved working distance**. This allows safe usage with less contamination when changing from oil to dry lenses. Combined with the new tube lens compensation concept, the result is a **fully corrected intermediate image without unnecessary colour correction and infringement**. New EC-H optics also offer **superior Digital imaging access** to the photo port of a trinocular tube for improved documentation results.



Magnification	N.A.	W.D. (mm)
EC-H Plan 2X	0.05	7,2
EC-H Plan 4X	0.10	15,9
EC-H Plan 10X	0.25	17,4
EC-H Plan 20X	0.45	0,9
EC-H Plan 40X	0.65	0,5
EC-H Plan 60X	0.80	0,35
EC-H Plan 100X-oil	1.25	0,15
EC-H PL Ph 10X	0.25	17,4
EC-H PL Ph 20X	0.45	0,9
EC-H PL Ph 40X	0.65	0,5
EC-H PL Ph 100X-oil	1.25	0,15
PL Fluor 4X	0.13	20,5
PL Fluor 10X	0.30	10,5
PL Fluor 20X	0.50	1,9
PL Fluor 40X	0.75	0,58
PL Fluor 50X-oil	1.0	0,17
PL Fluor 100X-oil	1.30	0,20

## Stage

Now with a **hard anodized coating**, scratch and chemical resistant, the ball-bearing driven mechanical stage offers a travel range of 76 x 50mm. The new improved double slide holder offers **better stability and durability** for multiple sample viewing. Available with either left or right-handed coaxial mechanical stage controls, the BA410's stage has a Vernier scale readability of 1mm. **Torque adjustment** is also available for both X and Y axes controls to suit individual user preferences.

A **newly developed stage lock mechanism** is located at the coarse focusing knob on the right side of the microscope. This new feature allows the user to determine a maximum stage height in order to **prevent unnecessary damage**.





## Condenser

The **standard condenser** is a **swing-out Achromatic type** with N.A. 0.90, providing homogeneous illumination for observation and photomicrography from 2X to 100X objective magnification. Condenser height is adjustable through a rack & pinion mechanism; while centering is done with a pair of adjustment screws on the condenser carrier.

**For Phase contrast**, a **slider** solution as well as a **turret** solution is available.

For raised samples e.g. sited in counting chambers, a **long working distance condenser** with W.D. 10.7mm and N.A. 0.65 is recommended for optimum Koehler illumination.

## Illumination

The BA410 introduces a **new collector lens assembly** with a secure, screw-on holder for frequently used daylight or other image enhancement filters - an integral part of any illumination package. The new fixed cap prevents the filter from dropping when the instrument is moved or stored.

The complete inner light path of the microscope has been enlarged to minimize diffraction effects at high illumination apertures. The Illumination is a **6V/30W Halogen Koehler system**.

A LED version is in preparation.

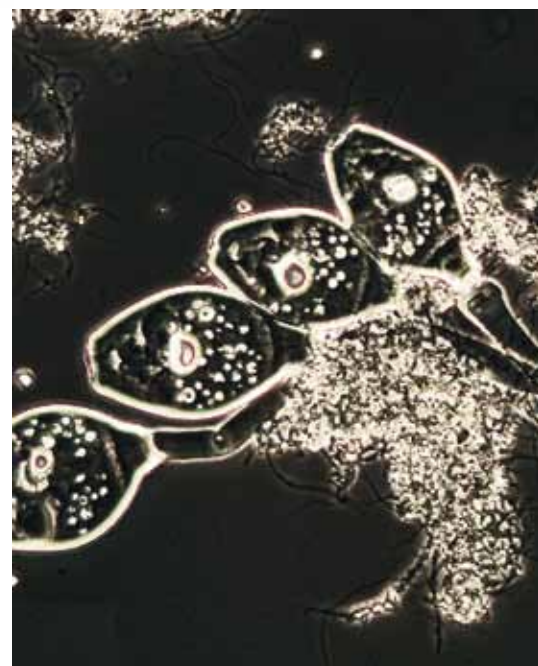





Phase contrast lenses

Phase contrast and Darkfield sliders

Condenser

## Phase Contrast & Darkfield

For Phase Contrast and Darkfield, the BA410 offers a **slider solution** of easy handling for single Phase contrast lenses, using an **optional slot condenser** for each magnification of 10X, 20X, 40X and 100X in combination with phase slider PH1, PH2 and PH3.

The new **EC-H Phase lenses** give a phase image with improved contrast and flatness. A respective **Darkfield slider** can be used from 4X to 40X lens magnification (N.A. up to 0.65). As a standard, positive phase contrast lenses are supplied. Negative phase contrast is available on request.

Adjustment of the phase rings is possible with two centering screws which are supplied with the phase sliders. For more advanced Phase contrast demands, a **turret condenser with phase rings for all objectives**, including a DF stop, is also available. Like the slider solution, the turret carries the light rings matching both positive and negative phase lenses.

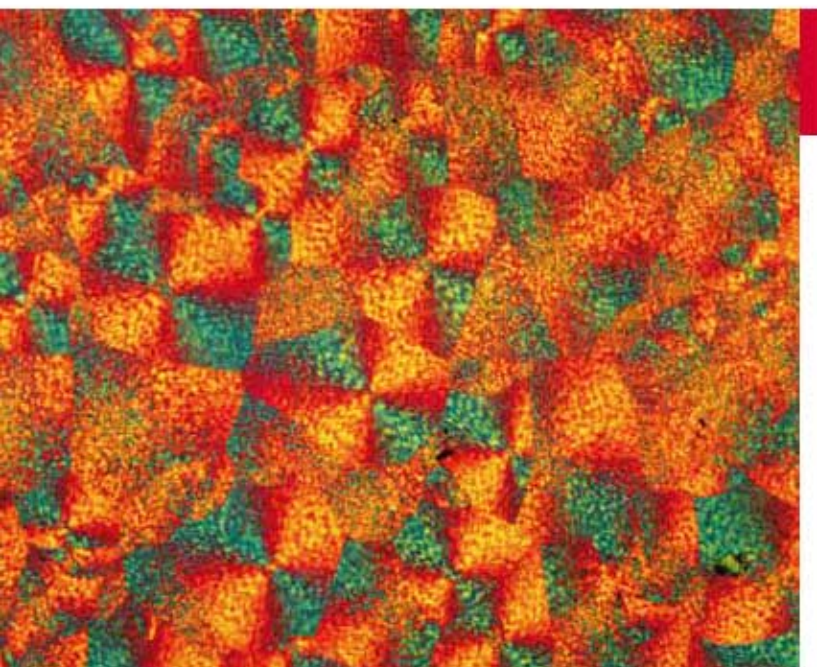

## Polarization

The BA410 is also equipped with 2 slots in the upper part of the stand. This is for placement of a rotatable analyzer and retardation plate (First Order Red Compensator). Together with the polarizer placed on top of the collector, polarization can be achieved.

Transition between bright field and polarized light is as easy as removing the analyzer slider. Using this normal polarisation setup enables the BA410 to be used as a rapid Gout Screening Analysis station.



CCD Adapters



### CCD Adapter

Newly designed CCD adapters, following the ISO standard with 38mm diameter, have improved optical characteristics to greatly enhance image reproduction quality.

The appropriate adapter has to be chosen in relation to the chip size of the used digital camera. The following "magnifications" are available: 1X, 0.65X, 0.5X.

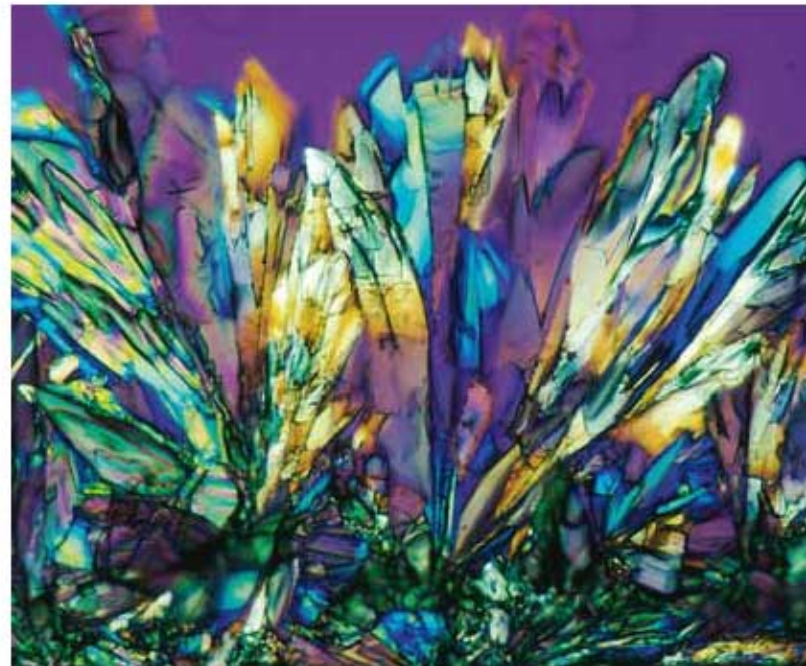

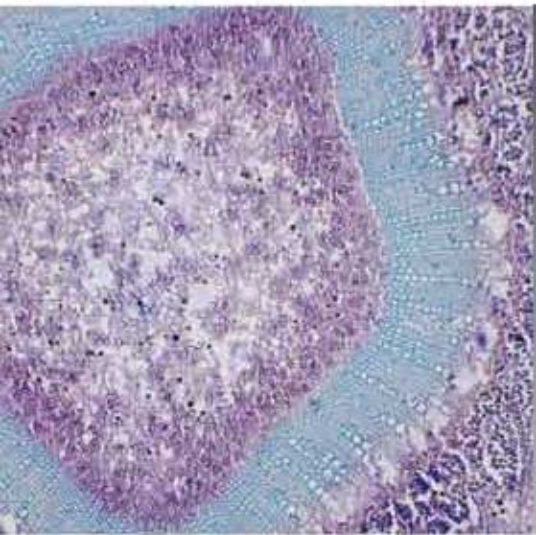

# Documentation

Today, accurate documentation is becoming an increasingly important part in most natural science applications.

In the new BA410 modular system the customer may choose between several different imaging options.

## Standard Photomicrography

The traditional use of a **single lens reflex camera** (analogue or digital) requires the trinocular version of the BA410. The adaptation of the camera consists of a **mechanical adapter** combined with a **photo eyepiece** (2.5X or 4X)

The necessary **T2 adapter** referring to the camera model is supplied by the camera manufacturer. This setup delivers high resolution images of small fields.

## Digital Documentation

A more convenient setup is provided through Motic's philosophy of easy image digitization. The combination of the BA410 with a member of the **Moticam** series of digital cameras delivers **excellent live images**, which can easily be stored for future usage.

All Motic cameras come equipped with software to transform the BA410 into an analysis and documentation station.

Motic offers a complete range of digital cameras starting with a basic resolution of 1.3MP (CMOS), up to the **Research grade Moticam Pro Line (CCD)**, with a maximum of 5MP, including **Monochrome** and **Cooled versions**. These Moticam cameras deliver sharp live images with easy post-capture handling.

The new Moticam Pro Line offers a research-grade solution for **demanding applications** like **EPI-Fluorescence** or **Darkfield**. CCD technology with high chip sensitivity is the basis for high-resolution images and colour-true results. Monochrome versions are available for maximum sensitivity as well as Peltier-cooled models for noise reduction. For further details on our range of cameras, as well as the different CCD adapters, please contact your nearest Motic office or your local authorized Motic reseller.

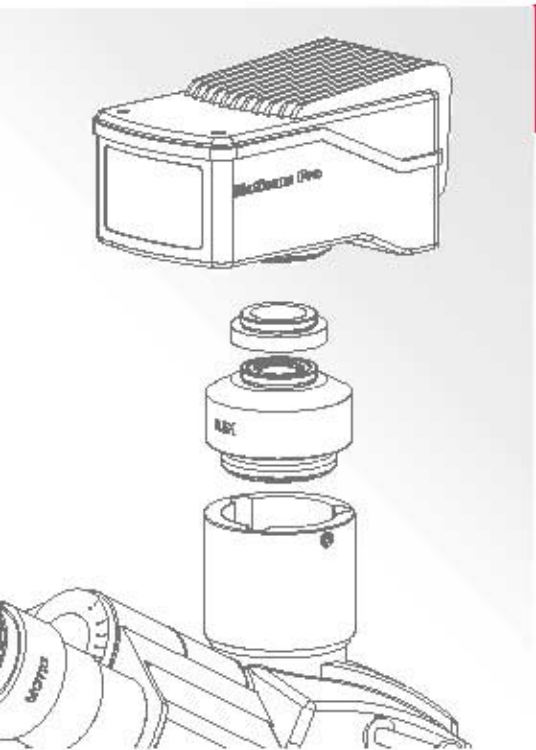

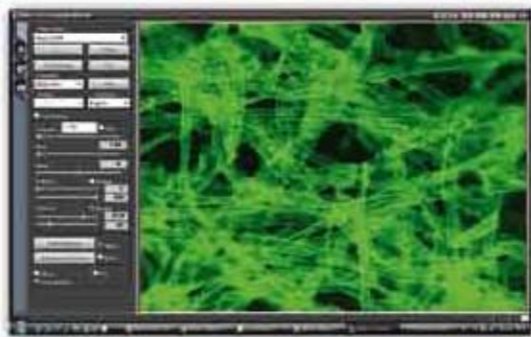
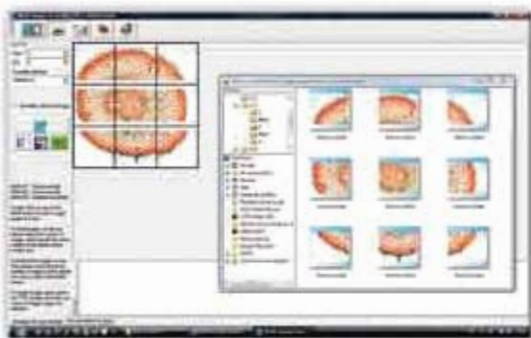

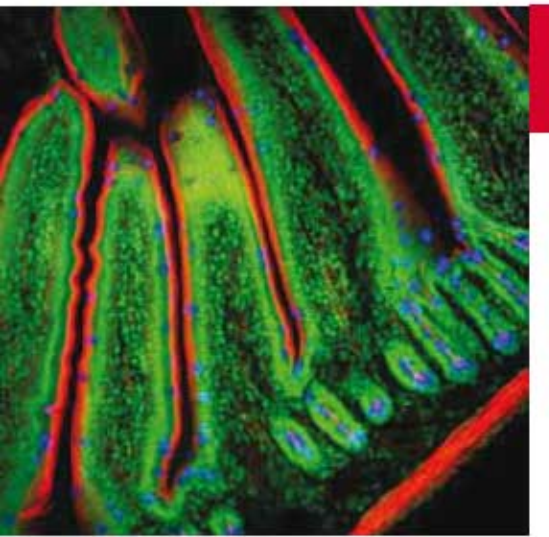

## Fluorescence Microscopy

The modular concept of the BA410 allows an easy upgrade to an EPI-Fluorescence microscope by using the fluorescence attachment. This device may carry up to 4 filter cubes. A complete range of filter cubes is available, covering all routine applications from UV up to NIR excitation. Supplied with band pass barrier filters, multi colour applications can also be performed

The newly designed XBE-HBO lamp house with improved light management offers more powerful excitation, resulting in brighter signals. In combination with a Moticam Pro Digital camera, excellent images are ensured.

Epi-fluorescence attachment

Specialized filter combinations are available on request.

Filter cassette  
Excitation selection knob

Lamphouse for Mercury Vapour lamp

UV light protective shield

Light trap

Starter unit

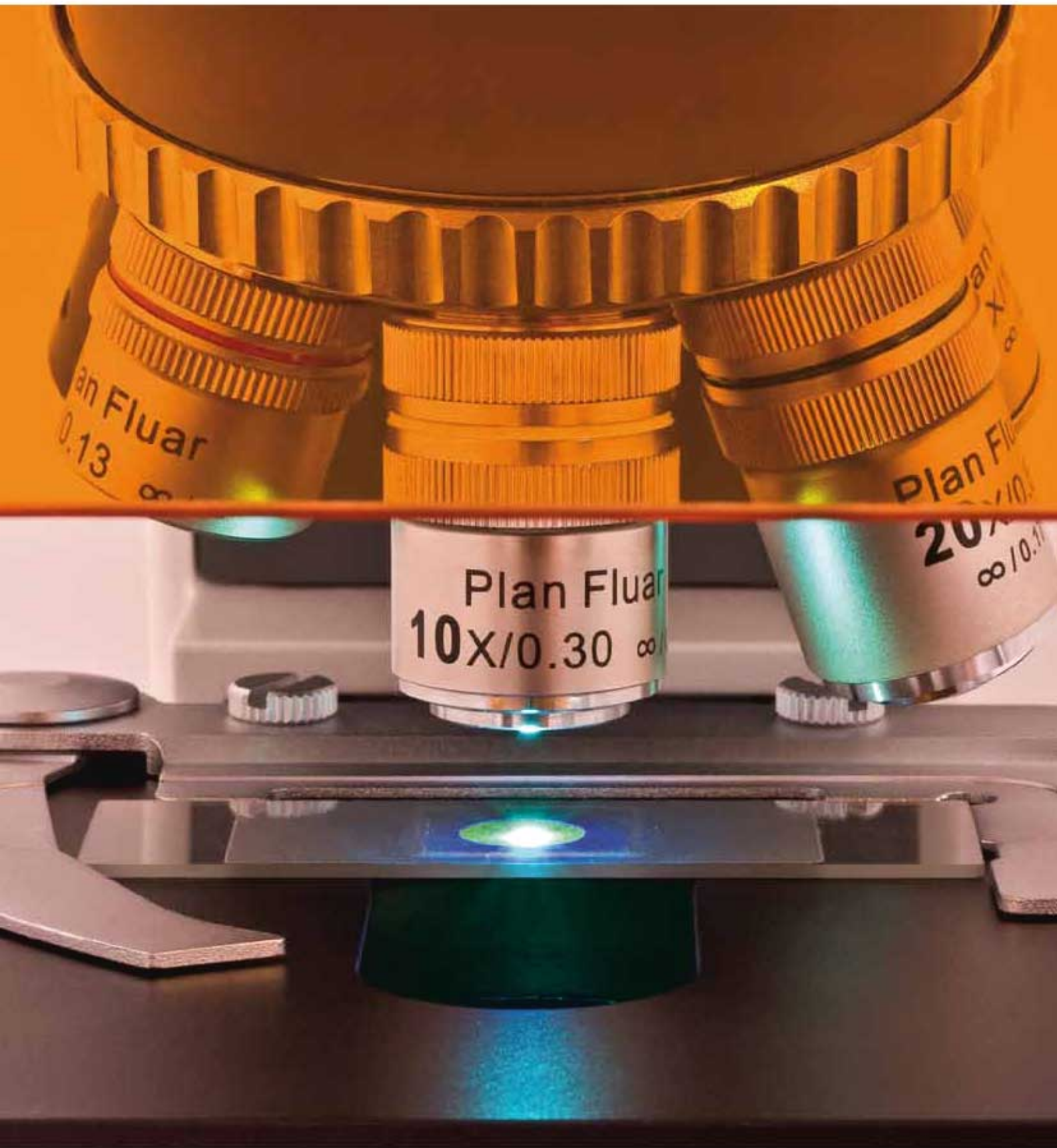





## BA410 Standard Specifications

<b>Model</b>	BA410
<b>Optical System</b>	Colour Corrected Infinity Optical System [CCIS®]
<b>Observation Tube</b>	Widefield binocular 30° [F.N. 22] Widefield trinocular 30° [F.N. 22]-light distribution 100:0/20:80 Widefield trinocular 30° [F.N. 22]-light distribution 100:0/0:100 Widefield trinocular 30° [F.N. 22]-light distribution 100:0/0:100/20:80
<b>Nosepiece</b>	Reversed quintuple or sextuple
<b>Stage</b>	174 x 145mm surface; 76 x 50mm movement; Hard anodized coated stage; coaxial movement X and Y with adjustable control knobs, stage with left or right hand control available
<b>Condenser</b>	Swing-out Abbe condenser N.A. 0.9/0.13
<b>Focus</b>	Z-axis movement 27mm with fixed upper limit stop for lens protection Coarse focus with torque adjustment Stage lock for high samples, freely definable Fine focus with 1µm minimum increment Silicon covered focus controls
<b>Illumination</b>	Externally mounted lamphouse, 6V/30W Quartz Halogen Koehler illumination

## BA410 Schematic Diagrams

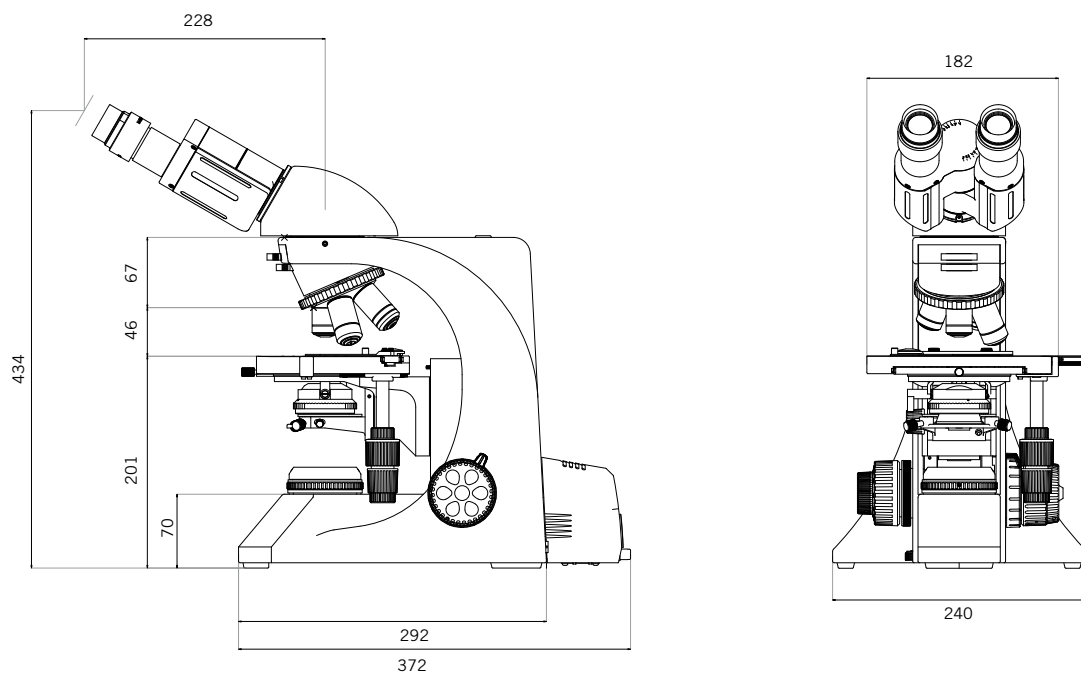

# BA410 System Diagram

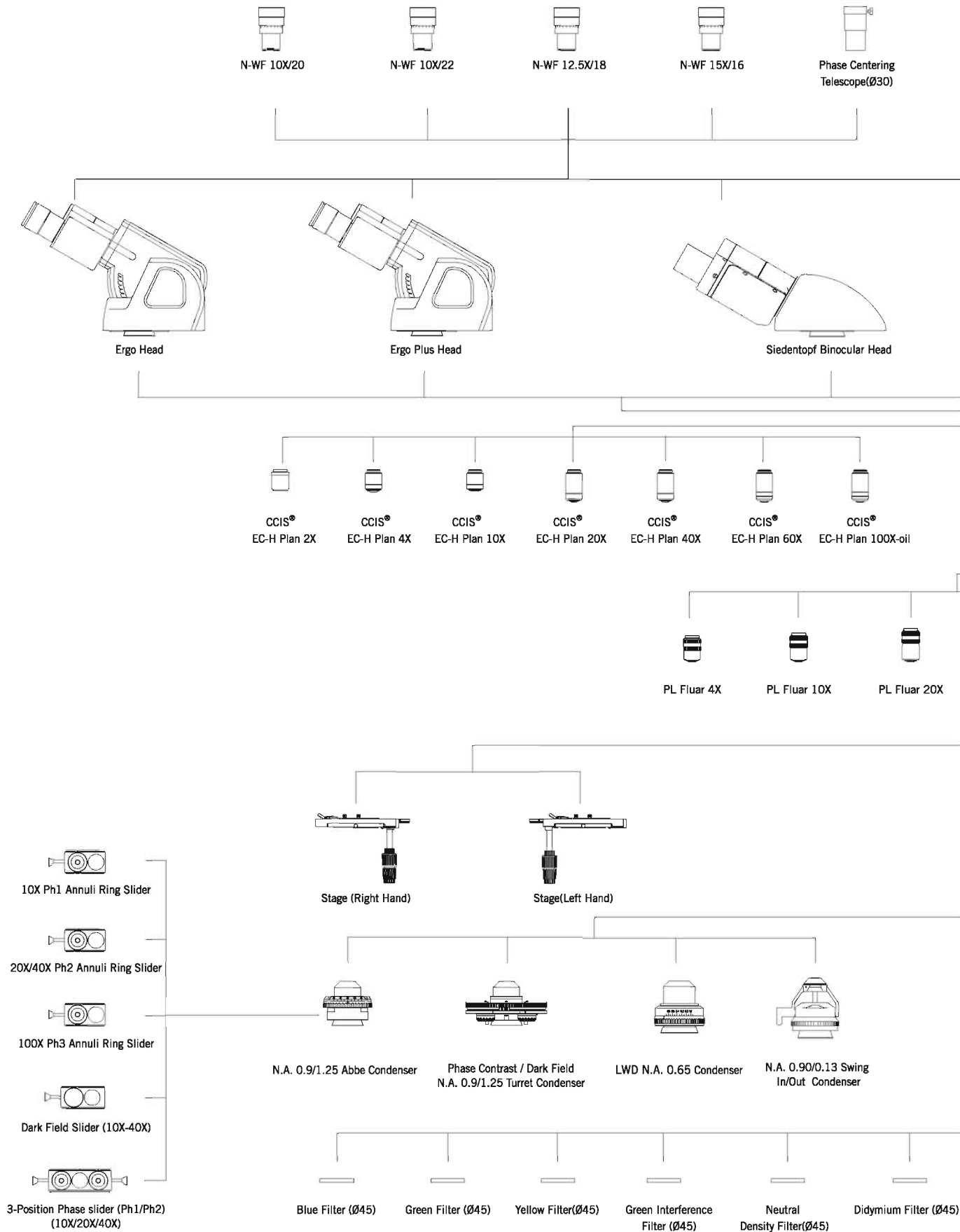

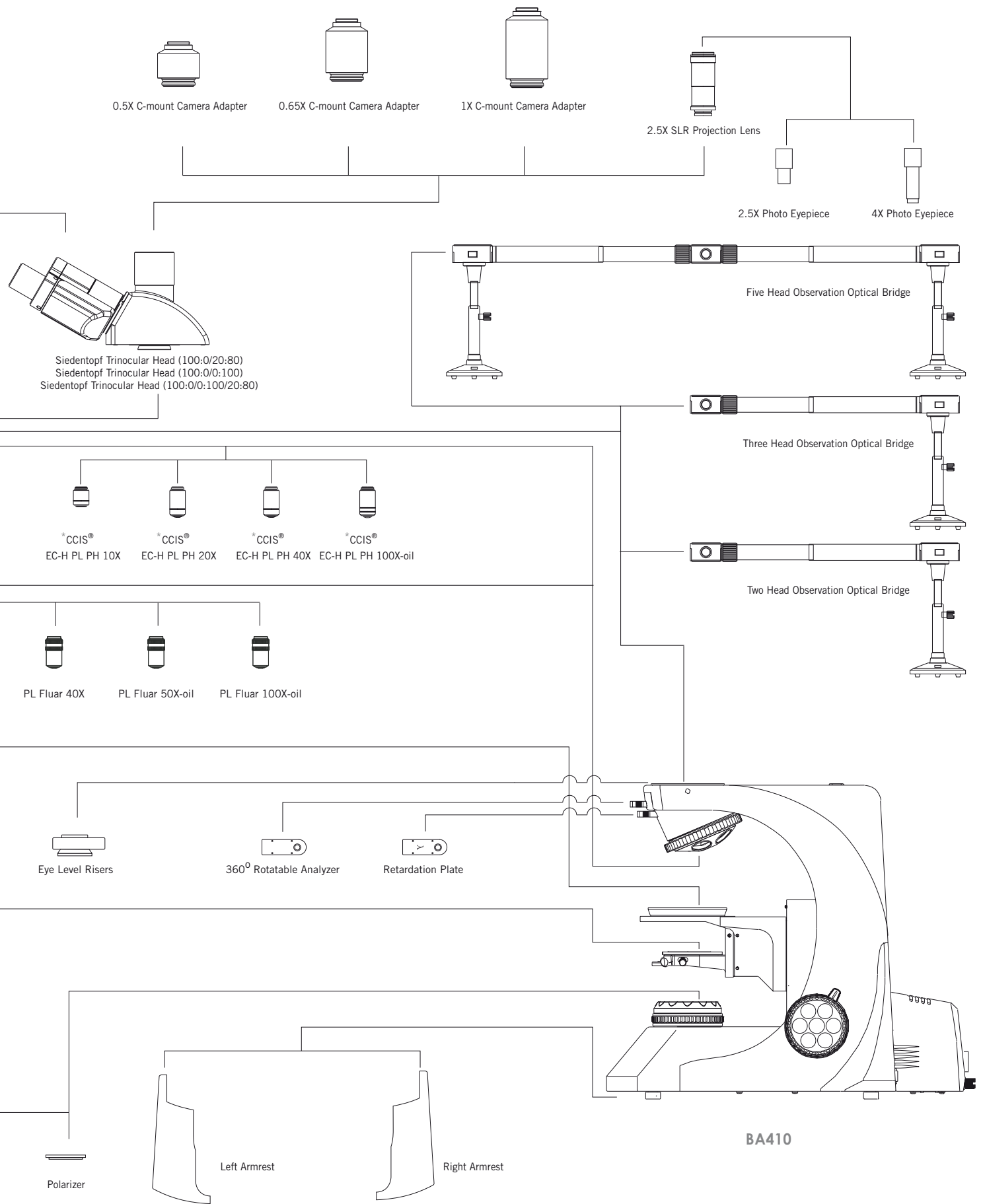

\* Standard: positive phase; negative phase available on request